

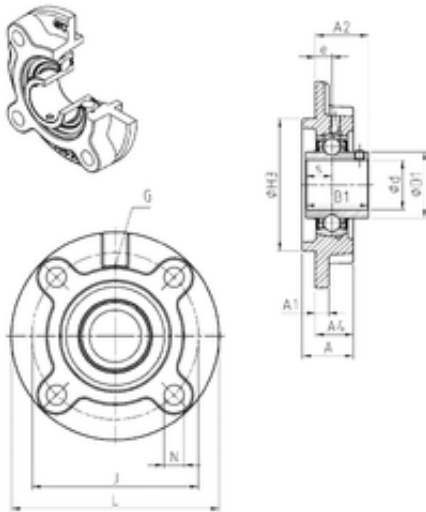

NTN Bearing Manufacturing



SNR UCFC206 bearing units

Bearing No. UCFC206

Bore Diameter	30 mm
d	30 mm
H3	80 mm
A4	23 mm
e	10 mm
s	15,9 mm
A	31 mm
A1	8 mm
B1	38,1 mm
D1	40,3 mm
J	100 mm
L	125 mm
N	12 mm
Thread (G)	M6x1
A2	32,2 mm
Weight	1,3 Kg
Basic dynamic load rating (C)	19,5 kN

UCFC206 Bearing 2D drawings and 3D CAD models