

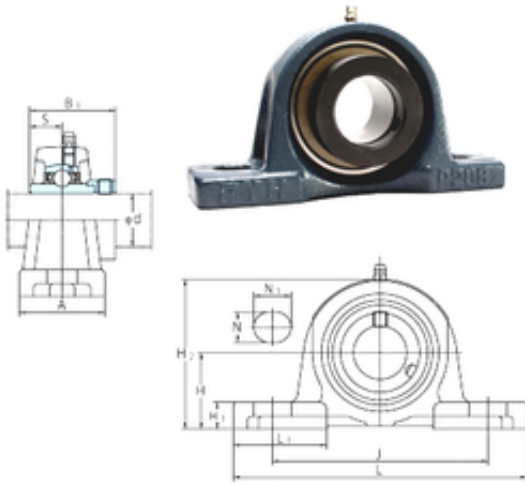

NTN Bearing Manufacturing

FYH NAP204-12 bearing units



Bearing No. NAP204-12

Bore Diameter	19,05 mm
Width	33,3 mm
d	19,05 mm
A	38 mm
B1	43,7 mm
H	33,3 mm
H1	13 mm
H2	64 mm
J	95 mm
L	127 mm
L1	38 mm
N	13 mm
N1	18 mm
S	17,1 mm
Bolt (G)	M10
Weight	0,73 Kg
Basic dynamic load rating (C)	12,8 kN

NAP204-12 Bearing 2D drawings and 3D CAD models