

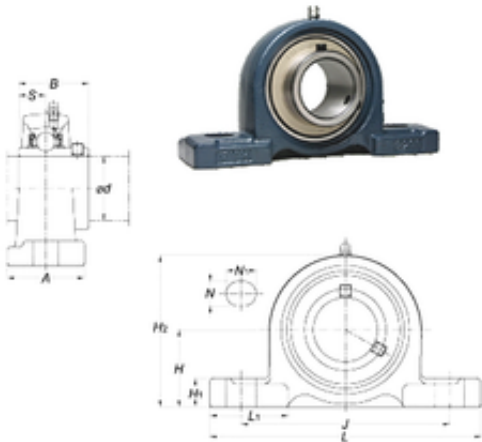

NTN Bearing Manufacturing

FYH UCP207-21 bearing units



Bearing No. UCP207-21

Bore Diameter	33,3375 mm
Width	42,9 mm
d	33,3375 mm
A	48 mm
B	42,9 mm
H	47,6 mm
H1	16 mm
H2	93 mm
J	127 mm
L	167 mm
L1	51 mm
N	17 mm
N1	21 mm
S	17,5 mm
Bolt (G)	M14
Weight	1,6 Kg
Basic dynamic load rating (C)	25,7 kN
Basic static load rating (C0)	15,4 kN

UCP207-21 Bearing 2D drawings and 3D CAD models