

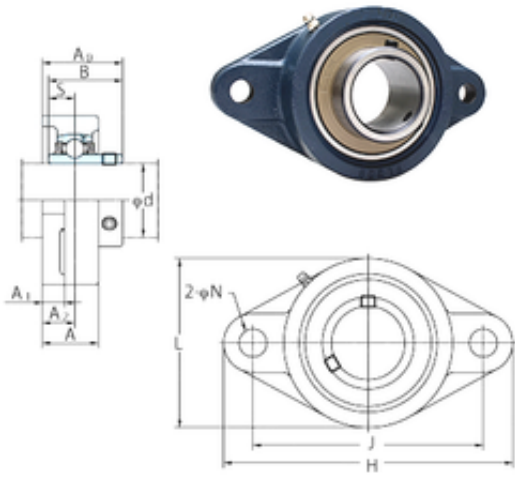

NTN Bearing Manufacturing

FYH UCFL202E bearing units

Bearing No. UCFL202E



UCFL202E Bearing 2D drawings and 3D CAD models

Bore Diameter	15 mm
d	15 mm
A0	33,3 mm
A	25,5 mm
A1	11 mm
B	31 mm
H	98 mm
J	76,2 mm
L	56 mm
N	10 mm
S	12,7 mm
A2	15 mm
Weight	0,4 Kg
Basic dynamic load rating (C)	12,8 kN
Basic static load rating (C0)	6,65 kN