

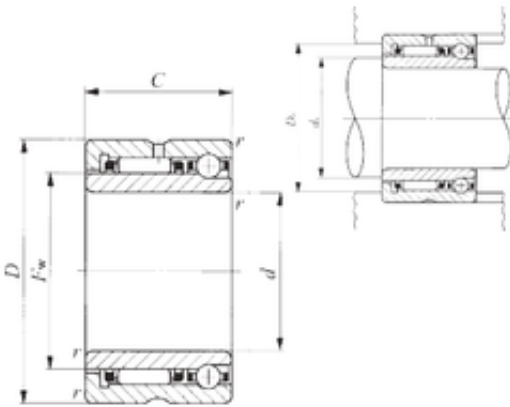

NTN Bearing Manufacturing

45 mm x 68 mm x 30 mm IKO NATA 5909 complex bearings



Bearing No. NATA 5909

Size	45x68x30 mm
Bore Diameter	45 mm
Outer Diameter	68 mm
Width	30 mm
d	45 mm
Fw	55 mm
D	68 mm
B	30 mm
C	30 mm
r min.	0,6 mm
da min.	49 mm
Da max.	64 mm
Weight	0,41 Kg
Dynamic load rating radial (C)	32,6 kN
Dynamic load rating axial (C)	5,45 kN
Static load rating radial (C0)	68,5 kN
Static load rating axial (C0)	12,7 kN

NATA 5909 Bearing 2D drawings and 3D CAD models