

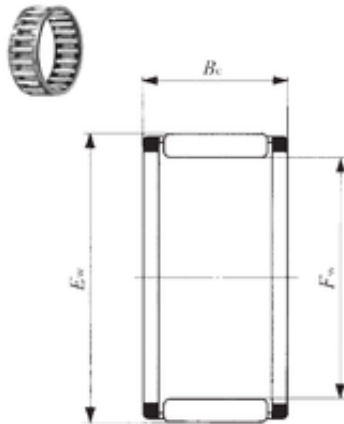

NTN Bearing Manufacturing



IKO KT 283317 needle roller bearings

Bearing No. KT 283317

Bore Diameter	28 mm
Outer Diameter	33 mm
Fw	28 mm
Ew	33 mm
Bc	17 mm
Weight	0,0189 Kg
Basic dynamic load rating (C)	18,3 kN
Basic static load rating (C0)	29,5 kN
Category	Needle Non Thrust Roller Bearings
Inventory	0.0
Manufacturer Name	IKO
Minimum Buy Quantity	N/A
Weight / Kilogram	0.02
EAN	4549557034947
Product Group	B04144
Rolling Element	Needle Roller Bearing
Component	Roller Assembly Only
Enclosure	Not Applicable
Self Aligning	No
Retainer	Yes
Number of Rows of Rollers	Single Row
Separable	No
Closed End	Not Applicable
Inch - Metric	Metric
Thrust Bearing	No

KT 283317 Bearing 2D drawings and 3D CAD models



NTN Bearing Manufacturing

Long Description	28MM Bore; 33MM Outside Diameter; 17MM Width; Needle Roller Bearing; Roller Assembly Only; Not Self Aligning; Retainer; Single Row of Rollers; Not Separable
Other Features	C3 Clearance
Category	Needle Non Thrust Roller Bearing
UNSPSC	31171512
Harmonized Tariff Code	8482.99.65.30
Noun	Roller Assembly
Keyword String	Bearing Needle
Manufacturer URL	http://www.ikont.com
Manufacturer Item Number	KT283317C3
Weight / LBS	0.042
Outside Diameter	1.299 Inch 33 Millimeter
Width	0.669 Inch 17 Millimeter
Bore	1.102 Inch 28 Millimeter