

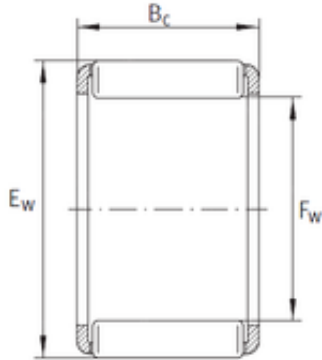

NTN Bearing Manufacturing

INA KZK 14x18x10 needle roller bearings



Bearing No. KZK 14x18x10

Bore Diameter	14 mm
Outer Diameter	18 mm
Fw	14 mm
Ew	18 mm
Bc	10 mm
Weight	4 Kg
Basic dynamic load rating (C)	7100 kN
Basic static load rating (C0)	8500 kN

KZK 14x18x10 Bearing 2D drawings and 3D CAD models