

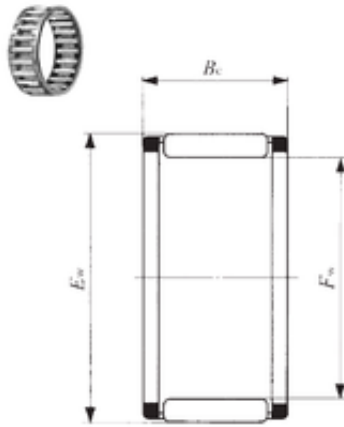

NTN Bearing Manufacturing

IKO KT 142012 needle roller bearings



Bearing No. KT 142012

Bore Diameter	14 mm
Outer Diameter	20 mm
Fw	14 mm
Ew	20 mm
Bc	12 mm
Weight	0,0087 Kg
Basic dynamic load rating (C)	9,79 kN
Basic static load rating (C0)	9,68 kN

KT 142012 Bearing 2D drawings and 3D CAD models